



# CorePro LED PLC

## CorePro LED PLC 6.5W 830 4P G24q-2

Philips CorePro LED PLC is the ideal uplamping solution for downlights in a wide range of general lighting applications. It integrates a LED light source into a traditional fluorescent form factor to offer superb energy savings over a lifetime that's twice as long as fluorescent alternatives.

### Product data

General Information	
Cap-Base	G24Q-2 [ G24q-2]
EU RoHS compliant	Yes
Nominal Lifetime (Nom)	30000 h
Switching Cycle	50000X
Light Technical	
Color Code	830 [ CCT of 3000K]
Luminous Flux (Nom)	650 lm
Correlated Color Temperature (Nom)	3000 K
Color Consistency	<6
Color Rendering Index (Nom)	83
LLMF At End Of Nominal Lifetime (Nom)	70 %
Operating and Electrical	
Input Frequency	30000-80000 Hz
Power (Nom)	6.5 W
Lamp Current (Max)	300 mA
Lamp Current (Min)	150 mA
Starting Time (Nom)	0.5 s
Warm Up Time to 60% Light (Nom)	0.5 s
Power Factor (Nom)	0.9

Voltage (Nom)	20-50 V
Temperature	
T-Ambient (Max)	35 °C
T-Ambient (Min)	-20 °C
T-Storage (Max)	65 °C
T-Storage (Min)	-40 °C
T-Case Maximum (Nom)	66 °C
Controls and Dimming	
Dimmable	No
Mechanical and Housing	
Product Length	100 mm
Approval and Application	
Energy Efficiency Label (EEL)	A+
Energy Saving Product	Yes
Approval Marks	TUV CE marking RoHS compliance KEMA Keur certificate
Energy Consumption kWh/1000 h	9 kWh

# CorePro LED PLC

## Product Data

Full product code	871869654119700
Order product name	CorePro LED PLC 6.5W 830 4P G24q-2
EAN/UPC - Product	8718696541197
Order code	929001201002
Numerator - Quantity Per Pack	1

Numerator - Packs per outer box	10
Material Nr. (12NC)	929001201002
Net Weight (Piece)	0.078 kg

## Warnings and Safety

## Dimensional drawing

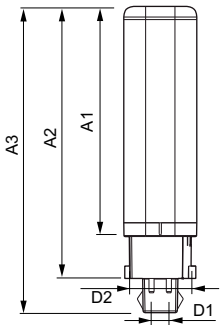

LEDtube PLC 6.5W G24q-2/830 4P

Product	D1	D2	A1	A2	A3
CorePro LED PLC 6.5W 830 4P G24q-2	24.3 mm	28.4 mm	105.8 mm	125 mm	140.6 mm

## Photometric data

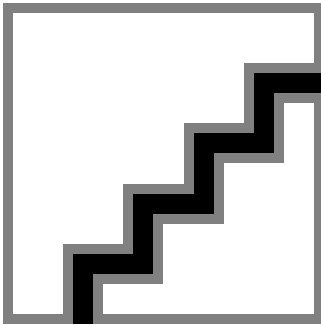

LEDtube PLC 100mm 7W G24Q-2 830 650lm

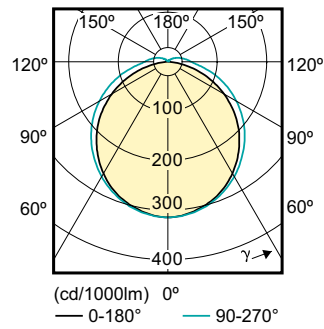

# CorePro LED PLC

## Lifetime

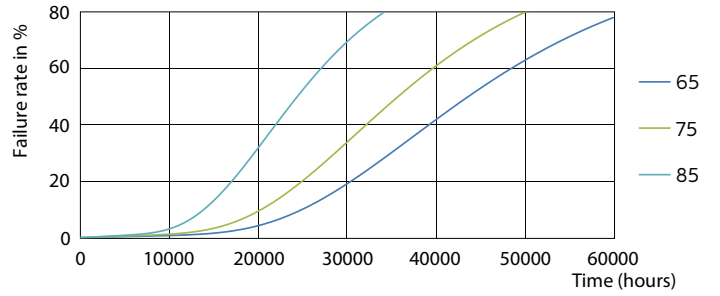
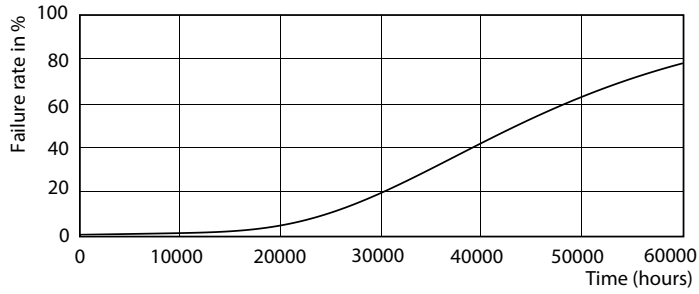

LEDtube PLC 100mm 7W G24Q-2 830 650lm

LEDtube PLC 100mm 7W G24Q-2 830 650lm

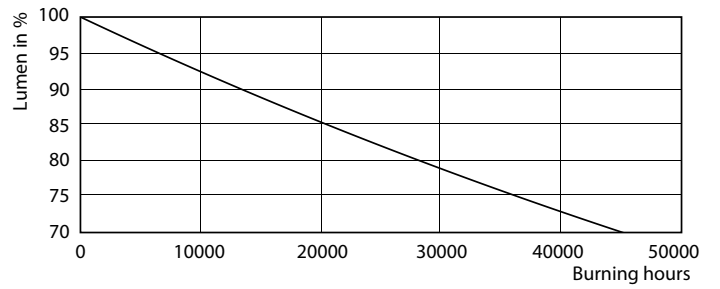
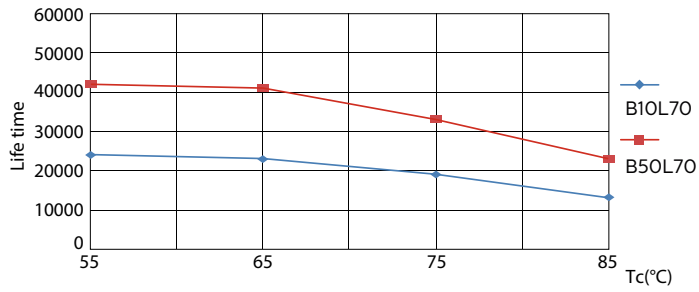

LEDtube PLC 100mm 7W G24Q-2 830 650lm

LEDtube PLC 100mm 7W G24Q-2 830 650lm

LEDtube PLC 100mm 7W G24Q-2 830 650lm

## CorePro LED PLC

