



# CorePro LED PLC

## CorePro LED PLC CorePro LED PLC 6.5W 840 4P G24q-2

Philips CorePro LED PLC is the ideal uplamping solution for downlights in a wide range of general lighting applications. It integrates a LED light source into a traditional fluorescent form factor to offer superb energy savings over a lifetime that's twice as long as fluorescent alternatives.

### Product data

General Information		Power factor (nom.)	
Cap base	G24Q-2 [ G24q-2]		0.9
Nominal lifetime (nom.)	30000 h	Voltage (Nom)	20-50 V
Switching cycle	50000X	<b>Temperature</b>	
B50L70	30000 h	T ambient (max.)	35 °C
<b>Light Technical</b>		T ambient (min.)	-20 °C
Colour code	840 [ CCT of 4,000 K]	T storage (max.)	65 °C
Luminous flux (nom.)	700 lm	T storage (min.)	-40 °C
Luminous flux (rated) (nom.)	700 lm	T-Case maximum (nom.)	66 °C
Correlated colour temperature (nom.)	4000 K	<b>Controls and Dimming</b>	
Colour consistency	<6	Dimmable	no
Colour rendering index (nom.)	83	<b>Mechanical and Housing</b>	
LLMF at end of nominal lifetime (nom.)	70 %	Product length	100 mm
<b>Operating and Electrical</b>		<b>Approval and Application</b>	
Input frequency	30000-80000 Hz	Energy efficiency label (EEL)	A+
Power (Rated) (Nom)	6.5 W	Energy-saving product	Yes
Lamp current (max.)	300 mA	Approval marks	CE marking RoHS compliance KEMA Keur certificate
Lamp current (min.)	150 mA		
Starting time (nom.)	0.5 s		
Warm-up time to 60% light (nom.)	0.5 s		

# CorePro LED PLC

Energy Consumption kWh/1000 h	9 kWh
<b>Product Data</b>	
Full product code	871869654121000
Order product name	CorePro LED PLC CorePro LED PLC 6.5W 840 4P G24q-2
EAN/UPC – product	8718696541210

Order code	54121000
Numerator – quantity per pack	1
Numerator – packs per outer box	10
Material no. (12NC)	929001201102
Net weight (piece)	0.078 kg

## Dimensional drawing

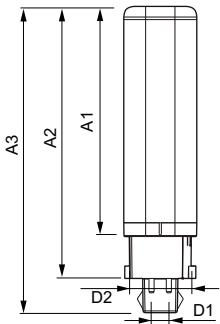

LEDtube PLC 6.5W G24q-2/840 4P

Product	D1	D2	A1	A2	A3
CorePro LED PLC CorePro LED PLC 6.5W 840 4P G24q-2	24.3 mm	28.4 mm	105.8 mm	125 mm	140.6 mm

## Photometric data

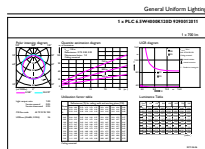

LEDtube PLC 100mm 7W G24Q-2 840 700lm

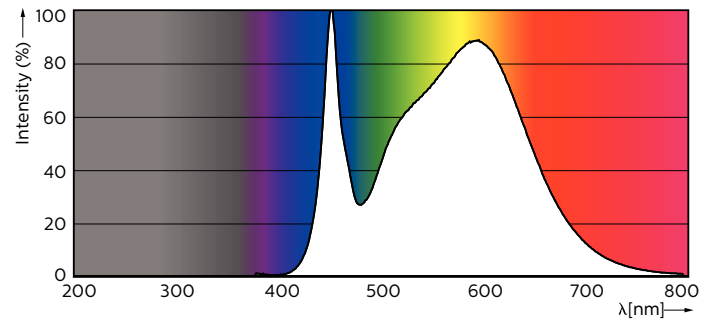

LEDtube PLC 100mm 9W G24Q-3 840 1000lm

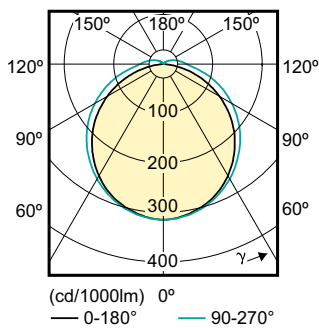

# CorePro LED PLC

## Lifetime

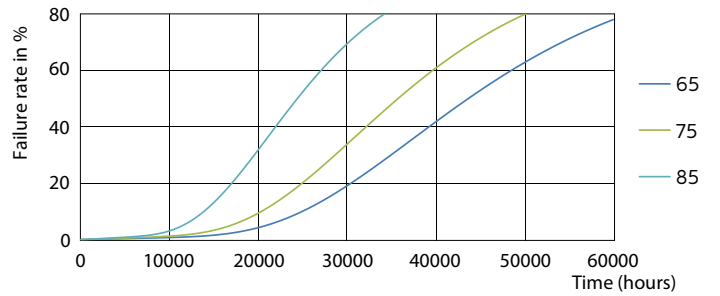
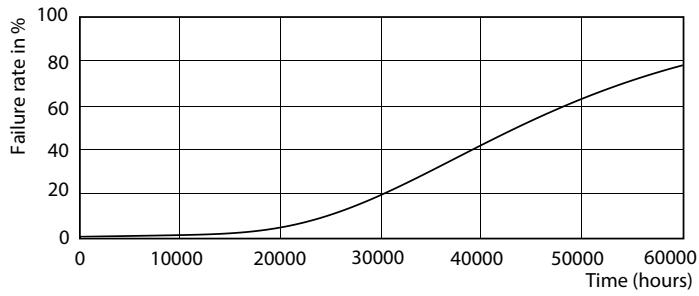

LEDtube PLC 100mm 7W G24Q-2 830 650lm

LEDtube PLC 100mm 7W G24Q-2 830 650lm

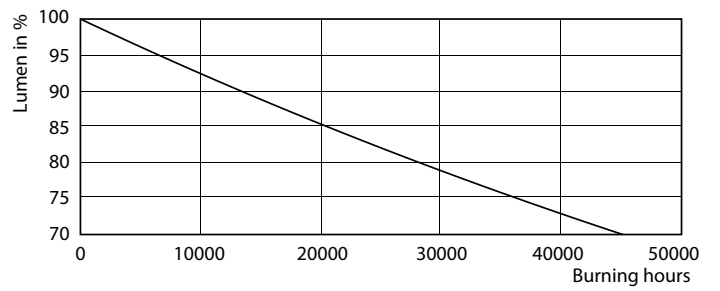
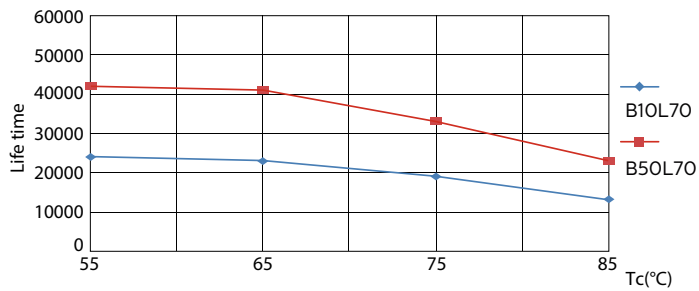

LEDtube PLC 100mm 7W G24Q-2 830 650lm

LEDtube PLC 100mm 7W G24Q-2 830 650lm

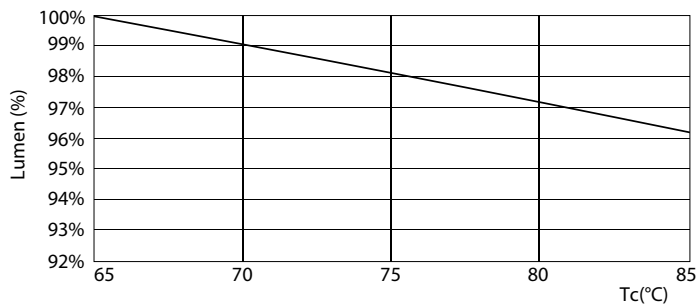

LEDtube PLC 100mm 7W G24Q-2 830 650lm

## CorePro LED PLC

