



CorePro LED PLC

CorePro LED PLC CorePro LED PLC 6.5W 840 2P G24d-2

Philips CorePro LED PLC is the ideal uplamping solution for downlights in a wide range of general lighting applications. It integrates a LED light source into a traditional fluorescent form factor to offer superb energy savings over a lifetime that's twice as long as fluorescent alternatives.

Product data

General Information		Power factor (nom.)	
Cap base	G24D-2 [G24d-2]		0.9
Nominal lifetime (nom.)	30000 h	Voltage (Nom)	220-240 V
Switching cycle	50000X	Temperature	
B50L70	30000 h	T ambient (max.)	35 °C
Light Technical		T ambient (min.)	-20 °C
Colour code	840 [CCT of 4,000 K]	T storage (max.)	65 °C
Luminous flux (nom.)	700 lm	T storage (min.)	-40 °C
Luminous flux (rated) (nom.)	700 lm	T-Case maximum (nom.)	65 °C
Correlated colour temperature (nom.)	4000 K	Controls and Dimming	
Colour consistency	<6	Dimmable	no
Color rendering index (nom.)	83	Mechanical and Housing	
LLMF at end of nominal lifetime (nom.)	70 %	Product length	100 mm
Operating and Electrical		Approval and Application	
Input frequency	50 to 60 Hz	Energy efficiency label (EEL)	A+
Power (Rated) (Nom)	6.5 W	Energy-saving product	Yes
Lamp current (max.)	35 mA	Approval marks	CE marking RoHS compliance KEMA Keur certificate
Lamp current (min.)	25 mA		
Starting time (nom.)	0.5 s		
Warm-up time to 60% light (nom.)	0.5 s		

CorePro LED PLC

Energy Consumption kWh/1000 h	9 kWh
Product Data	
Full product code	871869654129600
Order product name	CorePro LED PLC CorePro LED PLC 6.5W 840 2P G24d-2
EAN/UPC – product	8718696541296

Order code	54129600
Numerator – quantity per pack	1
Numerator – packs per outer box	10
Material no. (12NC)	929001201502
Net weight (piece)	0.077 kg

Dimensional drawing

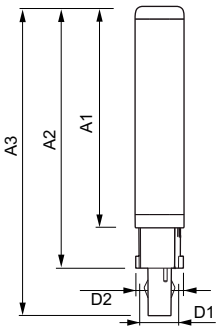

LEDtube PLC 6.5W G24d-2/840 2P

Product	D1	D2	A1	A2	A3
CorePro LED PLC CorePro LED PLC 6.5W 840 2P G24d-2	24.3 mm	28.4 mm	105.8 mm	125 mm	147.6 mm

Photometric data

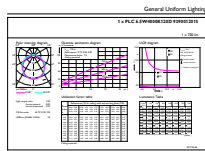

LEDtube PLC 100mm 7W G24D-2 840 700lm

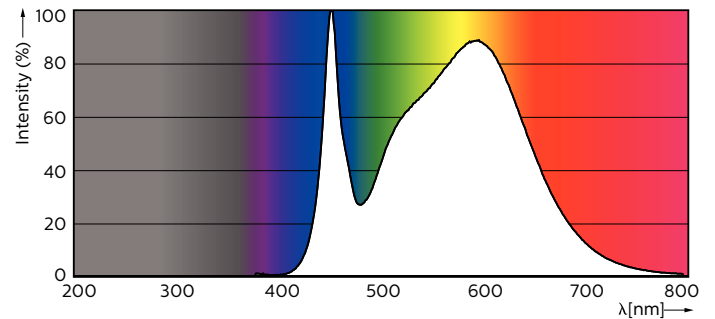

LEDtube PLC 100mm 9W G24Q-3 840 1000lm

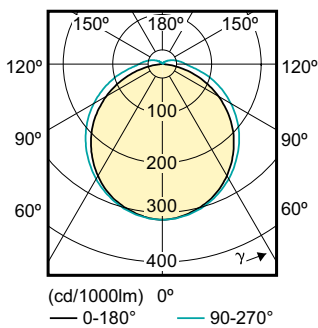

CorePro LED PLC

Lifetime

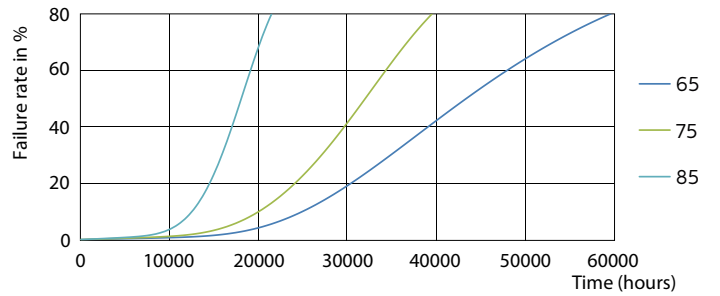
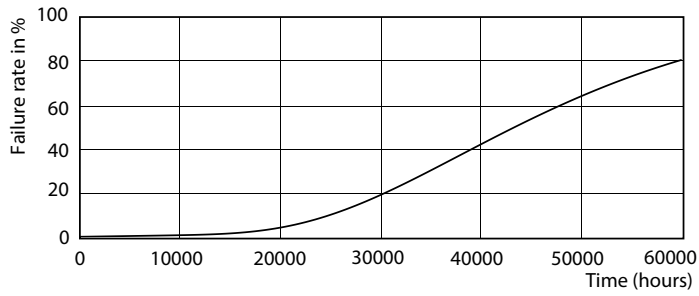

LEDtube PLC 100mm 7W G24D-2 830 650lm

LEDtube PLC 100mm 7W G24D-2 830 650lm

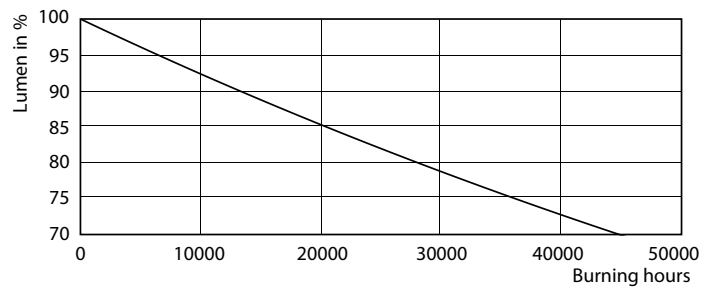
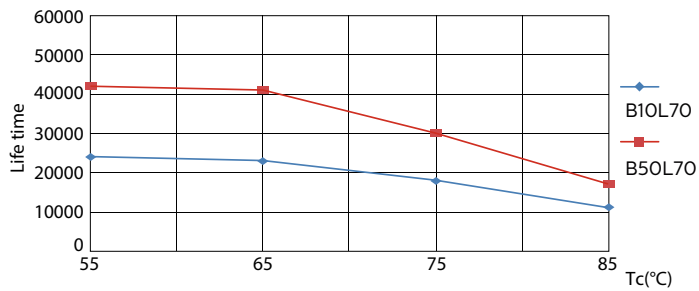

LEDtube PLC 100mm 7W G24D-2 830 650lm

LEDtube PLC 100mm 7W G24D-2 830 650lm

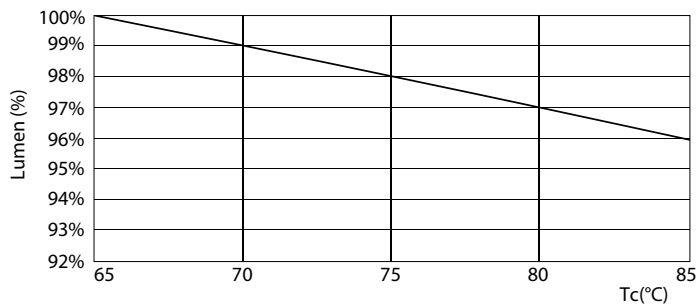

LEDtube PLC 100mm 7W G24D-2 830 650lm

